

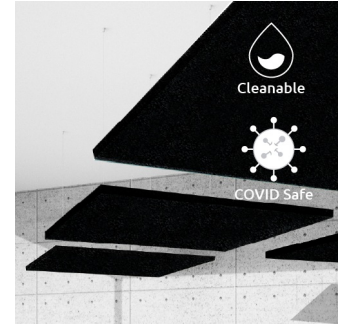

Performance

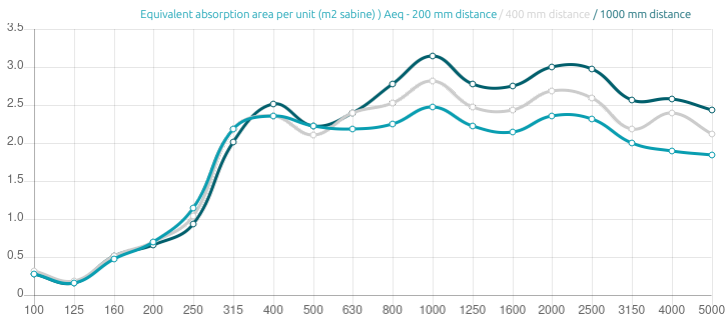

Technical Information

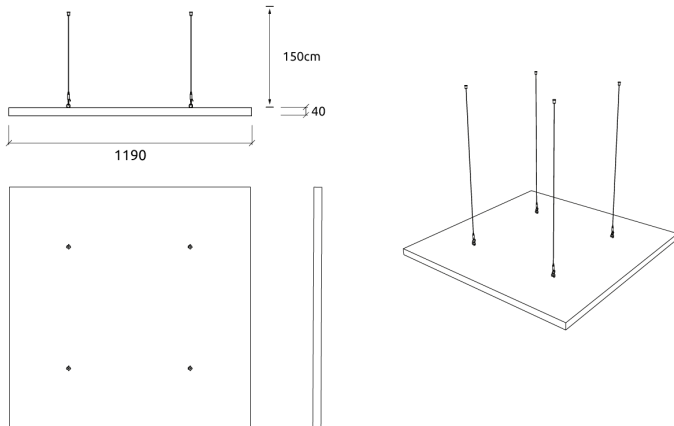

Features

Absorption Range: 350 Hz to 5000 Hz

Acoustic Class: C | (α_w) = 0,70

This product is available in the following Fire Rate:
FR | Fire Rated

PRODUCT COMPOSITION:

- Moritz | Polyethelene Foam (FR)
- Reversible: Closed Cell | Open Cell
- Euroclass B s1,d0

Installation:
- Ceiling suspension kit included

Dimensions:

FR | 1190x1190x40mm | 1.44 Kg

Moritz Cloud is a durable, semi-rigid closed-cell foam. It has an internal honeycomb-like structure that grants it exceptional performance. It is used to reduce reverberation or create a noise barrier in practically any type of environment, from high humidity areas such as swimming pools or outdoor spaces, to the most extreme high wear situations that require resistance to most chemicals and solvents, commonly found in healthcare environments or the manufacturing and service industries. Moritz is integrally fire retardant.

Moritz Cloud can be reversed to expose either an open-cell structure, that boosts high-frequency absorption, or closed-cell structure, for when the panel needs to be easily cleanable.

Moritz is lightweight and self-supporting. It is easily installed with the supplied cloud suspension systems, with adjustable hanging height up to 1,5m.

Product finishes

(FR) Product Fire Grade - Fire Rated



FR | (F04) Bianco | One
Side Open Cell, Other Side
Closed Cell



FR | (F05) Nero | One Side
Open Cell, Other Side
Closed Cell

Moritz Double SQR - Cloud MP

Acoustic washable foam

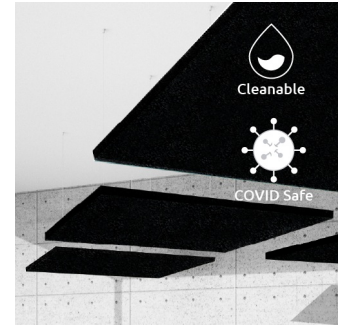

Purpose

- RT reduction
- Improving speech intelligibility
- High-frequency absorption
- Reducing excessive reverberation

Recommended for

- Industrial noise control
- Sanitary or harsh environments
- High humidity environments
- Outdoor spaces